

ZILFOR  
PRECISION FURNITURE

LISTE DE PRIX  
TTC 2019

<b>Colori</b>	4
<i>Colours, Couleurs, Farben</i>	
<b>Supplementi</b>	5
<i>Additional charges, Supplements, Zuschläge</i>	
<b>Aiuti per la progettazione</b>	7
<i>Helps for planning, Aides pour la project, Planungshilfe</i>	
<b>Serie Aurora</b>	10
<i>Aurora serie, Serie Aurora, Aurora Serie</i>	
<b>Elementi fissi</b>	11
<i>Fixed elements, elements fixes, feste Elemente</i>	
<i>Elementi su ruote</i>	21
<i>Elements on castors, elements mobiles, Beistellelemente</i>	
<b>Serie Prestige</b>	27
<i>Prestige serie, Serie Prestige, Prestige Serie</i>	
<b>Elementi fissi</b>	28
<i>Fixed elements, elements fixes, feste Elemente</i>	
<i>Elementi su ruote</i>	36
<i>Elements on castors, elements mobiles, Beistellelemente</i>	
<b>Serie Elite</b>	40
<i>Elite serie, Serie Elite, Elite Serie</i>	
<b>Elementi fissi</b>	41
<i>Fixed elements, elements fixes, feste Elemente</i>	
<i>Elementi su ruote</i>	49
<i>Elements on castors, elements mobiles, Beistellelemente</i>	
<b>Colonna</b>	51
<i>Tall unit, meuble colonne, Hochschrank</i>	
<b>Pensili</b>	52
<i>Wall units, Armoires murales, Hängeschränke</i>	
<b>Piani top</b>	55
<i>Worktops, Plans de travail, Arbeitsplatten</i>	
<b>Lavorazioni supplementari</b>	58
<i>Special manufacturings, Fabrications speciales, Zusätzliche Bearbeitungen</i>	

---

---

Alzatine <i>Backsplashes, Dosserets, Abschlussleisten</i>	60
Piani servomobile <i>Tops for mobile elements, Plans pour elements sur roulettes, Arbeitsplatten für Beistellelemente</i>	61
<b>Bacinelle</b> <i>Basins, Interieurs des tiroirs, Einsätze</i>	62
<b>Carrelli</b> <i>Trolleys, Chariots, Rollwagen</i>	64
<b>Sedie</b> <i>Chairs, Sièges, Stühle</i>	68
Elementi da combinare <i>Elements to combine, Elements à combiner, Kombinierbare Elemente</i>	69
<b>Aspirazione portatile</b> <i>Portable suction unit, Aspiration portative, Tragbare Absaugung</i>	71
<b>Amico Box</b> <i>Amico box, Amico box, Amico box</i>	73
<b>Micromotore</b> <i>Micromotor, Micromoteur, Mikromotor</i>	76
<b>Accessori</b> <i>Accessories, Accessoires, Zubehör</i>	77
<b>Condizioni generali di vendita</b> <i>General sale conditions, Conditions generales de vente, Haupt- Allgemeine Geschäftsbedingungen</i>	92

---

MOBILI  
FURNITURE  
MEUBLES  
KORPUS

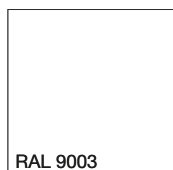
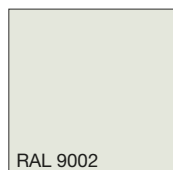

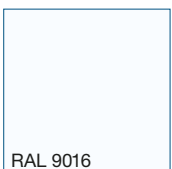
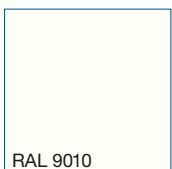
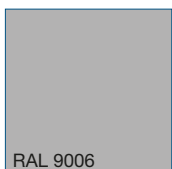
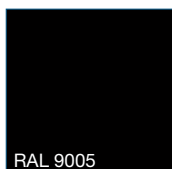
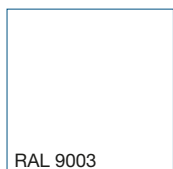
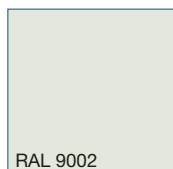
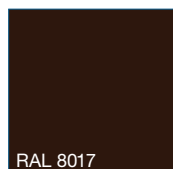
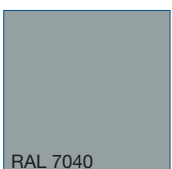
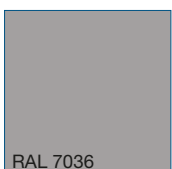
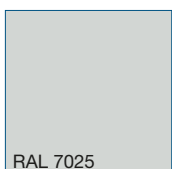
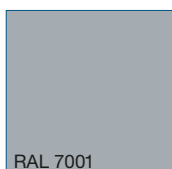
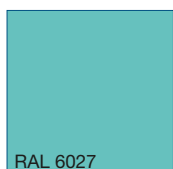
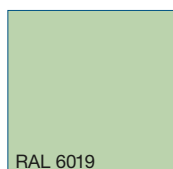
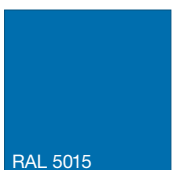
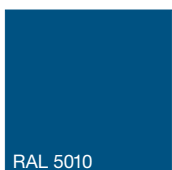
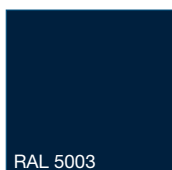
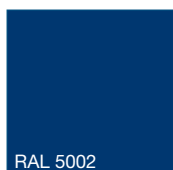
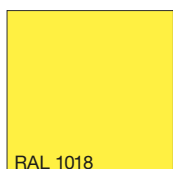
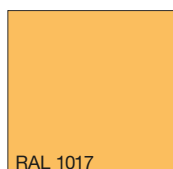
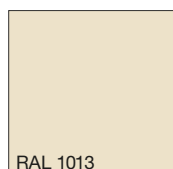

Bianco Euro  
Euro White  
Blanc Euro  
Euroweiß

MANIGLIE  
HANDLES  
POIGNEES  
GRIFFE

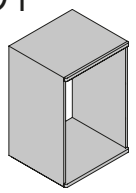
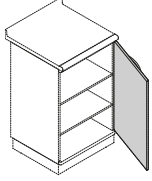
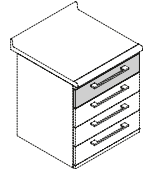
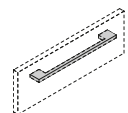
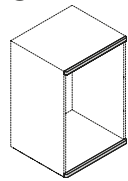
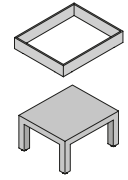
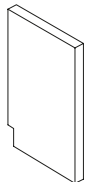
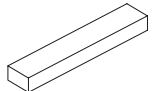

Euro

SC1		<p><b>Mobile (fusto)</b> Item Élément Korpus</p>	<p>al pezzo per unit chaque pièce pro Stück</p>	<p>78</p>		
SC2		<p><b>Porta</b> Door Porte Tür</p>	<p>al pezzo per unit chaque pièce pro Stück</p>	<p>36</p>		
SC3		<p><b>Frontale</b> Front drawer Façade Front</p>	<p>al pezzo per unit chaque pièce pro Stück</p>	<p>21</p>		
SC4		<p><b>Maniglia</b> Handle Poignée Griff</p>	<p>al pezzo per unit chaque pièce pro Stück</p>	<p>14</p>		
SC5		<p><b>Liste superiori e inferiori</b> Upper and lower profiles Listes inférieurs et supérieurs Ober-und Unterprofile</p>	<p>al pezzo per unit chaque pièce pro Stück</p>	<p>21</p>		
SC6		<p><b>Zoccolo</b> Plinth Socle Sockel</p>	<p>al pezzo per unit chaque pièce pro Stück</p>	<p>25</p>		
SC7		<p><b>Supporto verticale ELITE</b> Vertical support ELITE Support vertical ELITE Vertikaler Unterstützung ELITE</p>		<p><b>Supporto orizzontale ELITE</b> Horizontal support ELITE Support horizontal ELITE Horizontaler Unterstützung ELITE</p>	<p>al pezzo per unit chaque pièce pro Stück</p>	<p>25</p>
SGQ		<p><b>Supplemento per guide a rientro automatico e guide push-pull</b> Additional charge for self-closing and push-pull system of drawers Supplement pour système automatique et push-pull des glissières Zuschlag für gedämpfte Führungen</p>	<p>a coppia per set au paire pro Paar</p>	<p>48</p>		

Euro

## SMAI

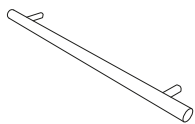

**Supplemento per maniglia inox**  
Additional charge for inox handle  
Supplément pour poignée en inox  
Zuschlag für Edelstahlgriff

**al pezzo**  
per unit  
chaque pièce  
pro Stück

21

## SMAM2

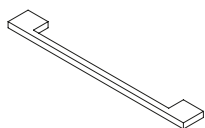

**Supplemento per maniglia Elite L.40 cm**  
Additional charge for Elite rectangular handle L.40 cm  
Supplément pour poignée Elite L. 40 cm  
Zuschlag für rechteckigen Griff Mod. Elite L.40 cm

**al pezzo**  
per unit  
chaque pièce  
pro Stück

29

## SMAAI

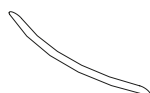

**Supplemento per maniglia Elite L.40 cm**  
Additional charge for Elite rectangular handle L.40 cm  
Supplément pour poignée Elite L. 40 cm  
Zuschlag für rechteckigen Griff Mod. Elite L.40 cm

**al pezzo**  
per unit  
chaque pièce  
pro Stück

12

**ELEMENTI SU RUOTE SERIE AURORA**  
**ELEMENTS MOBILES SERIE AURORA**

**ELEMENTS ON CASTORS AURORA SERIE**  
**BEISTELLELEMENTE SERIE AURORA**

N.B.: Il peso degli elementi non include il piano top  
 N.B.: The weight of the elements doesn't include the worktop  
 N.B.: Le poids des éléments ne comprend pas le plan  
 Bitte beachten: Das Gewicht der Elemente beinhaltet nicht das Top

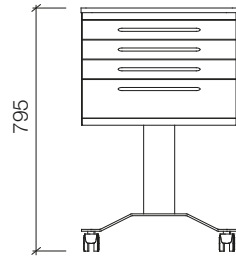

**LAMINATO**  
 LAMINATE  
 LAMINÉ  
 LAMINAT

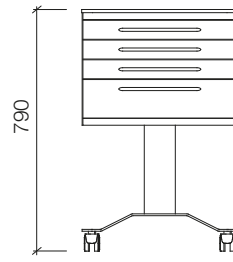

**VETRO**  
 GLASS  
 VERRE  
 GLAS

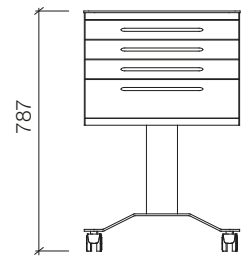

**CORIAN**  
 CORIAN  
 CORIAN  
 CORIAN

AURORA

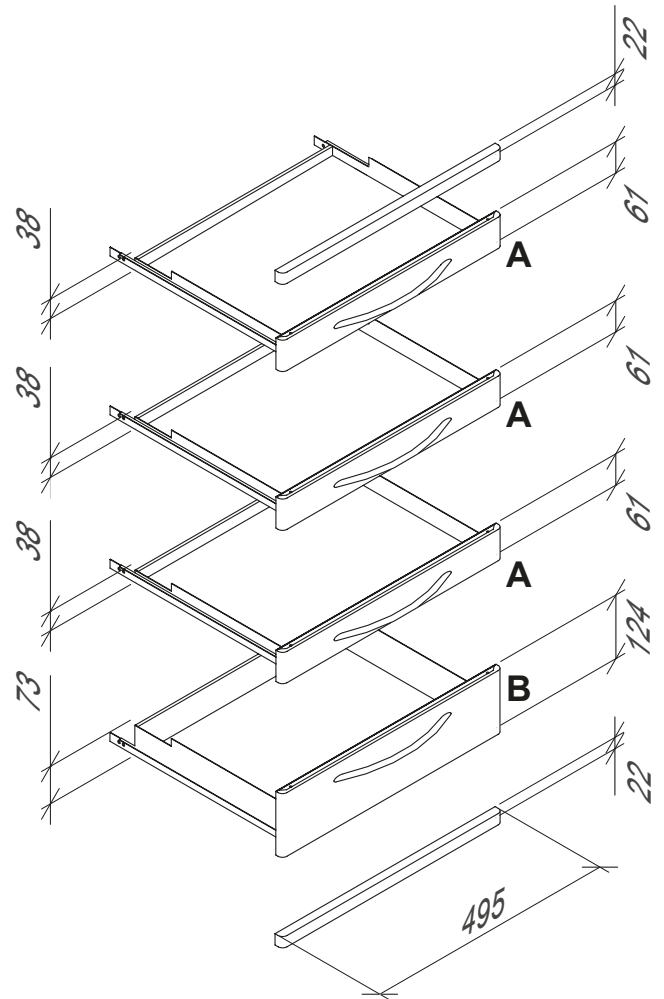
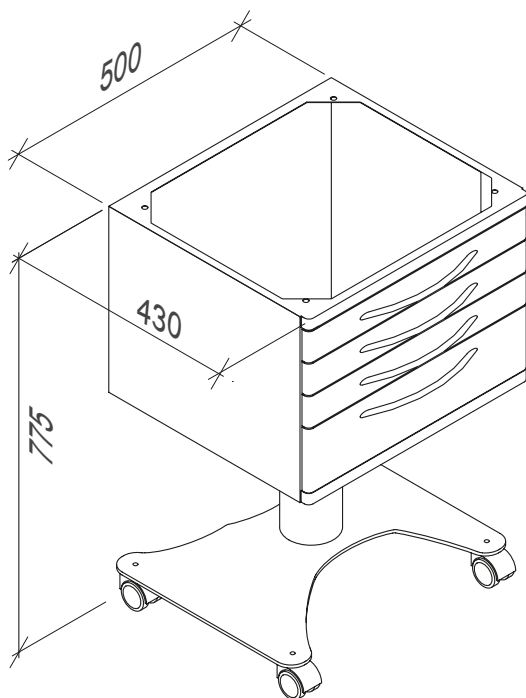

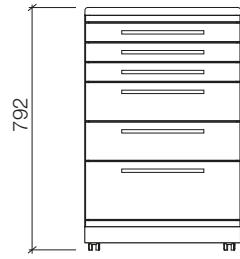

LAMINATO  
LAMINATE  
LAMINÉ  
LAMINAT

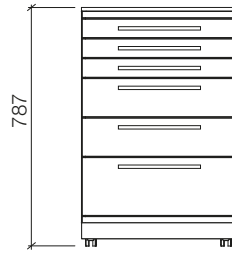

VETRO  
GLASS  
VERRE  
GLAS

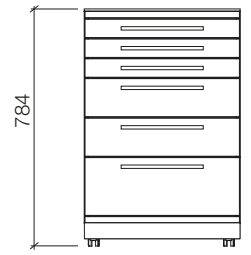

CORIAN  
CORIAN  
CORIAN  
CORIAN

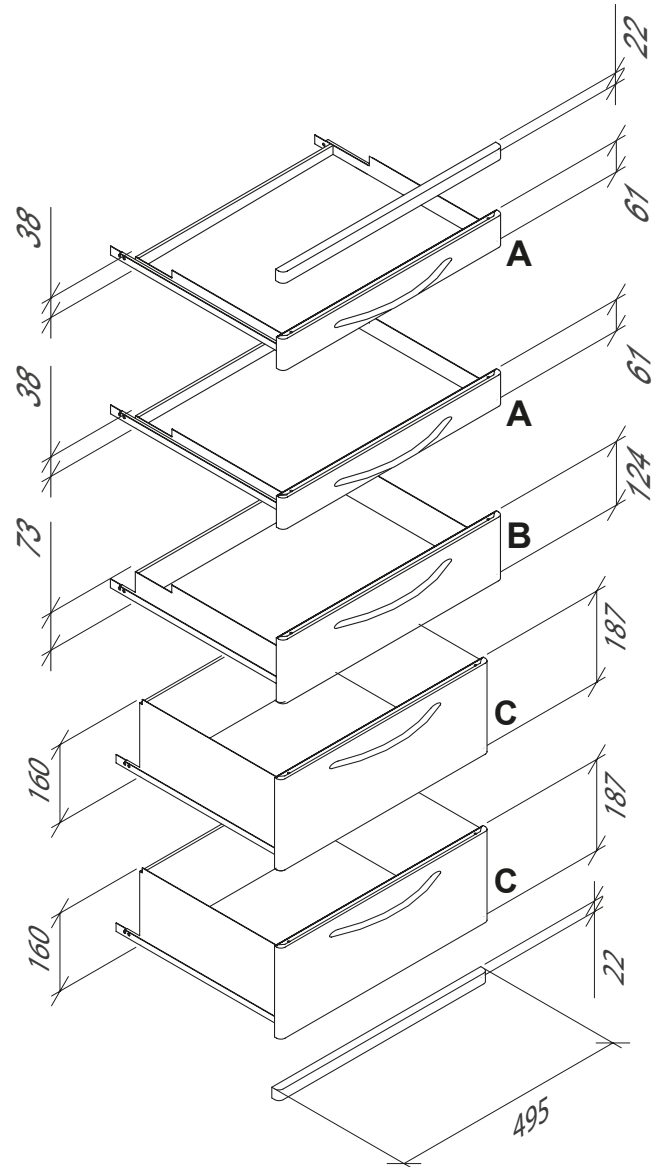
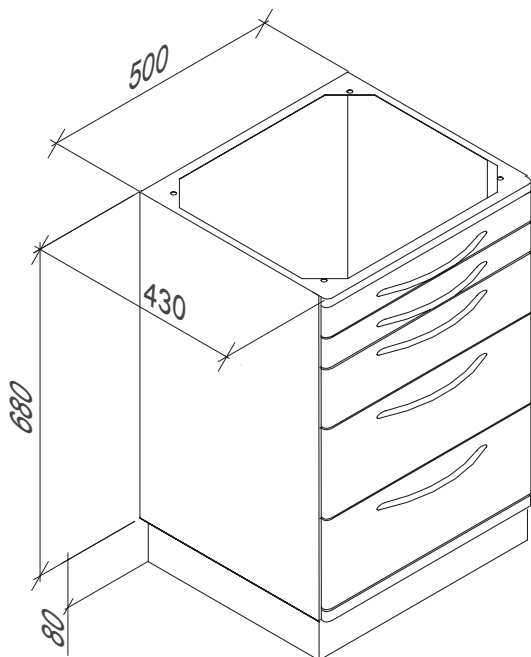



## ELEMENTI SU RUOTE L.50 CM

## ELEMENTS MOBILES L.50 CM

## ELEMENTS ON CASTORS L.50 CM

## BEISTELLELEMENTE BR. 50 CM

N.B.: Il prezzo è comprensivo di piano

N.B.: The price includes the worktop

N.B.: Dans le prix est inclus le plan

Bitte beachten: Der Preis beinhaltet die Arbeitsplatte

## RC4Z

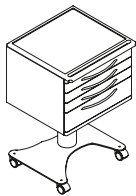

Kg. 32

**Elemento su carrello 3 cassetti A - 1 B**

3 bacinelle - 1 fondo PVC

Element on castors 3 A drawers - 1 B drawer

3 trays - 1 PVC bottom

Elément mobile sur cart avec 3 tiroirs A - 1 B

3 intérieurs de tiroirs - 1 fond en PVC

Element auf Rollen 3 A Schubladen - 1 B Schublade

3 Einsätze - 1 PVC Boden

Euro		
laminato laminated laminé	vetro glass verre glas	Corian Corian Corian Corian

941

1154

1140

## RC4K

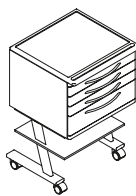

Kg. 29

**Elemento su carrello 3 cassetti A - 1 B**

3 bacinelle - 1 fondo PVC

Element on castors 3 A drawers - 1 B drawer

3 trays - 1 PVC bottom

Elément mobile sur cart avec 3 tiroirs A - 1 B

Element auf Rollen 3 A Schubladen - 1 B Schublade

3 Einsätze - 1 PVC Boden

893

1099

1092

## RT5



Kg. 36

**Elemento 2 cassetti A - 1 B - 2 C**

3 bacinelle - 2 fondi PVC

2 A drawers - 1 B drawer - 2 C drawers unit

3 trays - 2 PVC bottoms

Elément 2 tiroirs A - 1 B - 2 C

3 intérieurs de tiroirs - 2 fonds en PVC

Element 2 A Schubladen - 1 B Schublade - 2 C Schubladen

3 Einsätze - 2 PVC Böden

948

1160

1147

## RT6

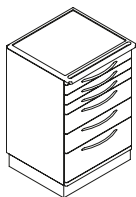

Kg. 38

**Elemento 3 cassetti A - 2 B - 1 C**

4 bacinelle - 2 fondi PVC

3 A drawers - 2 B drawers - 1 C drawer unit

4 trays - 2 PVC bottoms

Elément 3 tiroirs A - 2 B - 1 C

4 intérieurs de tiroirs - 2 fonds en PVC

Element 3 A Schubladen - 2 B Schubladen - 1C Schublade

4 Einsätze - 2 PVC Böden

1085

1284

1277

## RT7

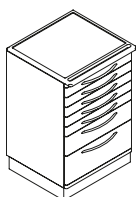

Kg. 40

**Elemento 5 cassetti A - 1 B - 1 C**

5 bacinelle - 2 fondi PVC

5 A drawers - 1 B drawer - 1 C drawer unit

5 trays - 2 PVC bottoms

Elément 5 tiroirs A - 1 B - 1 C

5 intérieurs de tiroirs - 2 fonds en PVC

Element 5 A Schubladen - 1 B Schublade - 1C Schublade



5 Einsätze - 2 PVC Böden

1154

1366

1353

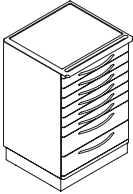
AURORA

		Euro		
		laminato laminat laminé laminat	vetro glass verre glas	Corian Corian Corian Corian
<b>RT8</b>				
	<p><b>Elemento 6 cassetti A - 2 B</b> 6 bacinelle - 2 fondi PVC 6 A drawers - 2 B drawers 6 trays - 2 PVC bottoms Elément 6 tiroirs A - 2 B 6 intérieurs de tiroirs - 2 fonds en PVC Element 6 A Schubladen - 2 B Schubladen 6 Einsätze - 2 PVC Böden</p>	1174	1387	1373
Kg. 42				
<b>RTEM2</b>				
	<p><b>Elemento 2 piani estraibili portastrumenti</b> antina a scomparsa 2 cassetti B 1 bacinella - 1 fondo in PVC Unit with 2 extractable surgical instruments holders disappearence door 2 B drawers 1 tray - 1 PVC bottom Eléments 2 plans extractibles porte instruments porte escamotable 2 tiroirs B - 1 intérieur de tiroirs - 1 fond en PVC Element mit 2 ausziehbaren Ablageflächen f. die Instrumente Versenkbare kl. Tür - 2B Schubladen 1 Einsatz - 1 PVC Boden</p>	1236	1442	1428
Kg. 36				

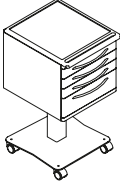
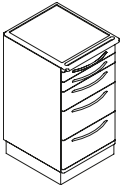
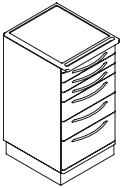
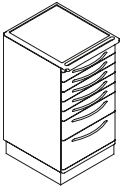
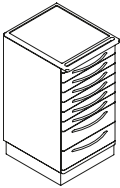
		Euro		
		laminato laminat laminé laminat	vetro glass verre glas	Corian Corian Corian Corian
<b>RC4S</b>	 <p><b>Elemento su carrello L. 40 cm,</b> 3 cassetti A - 1 B, 3 bacinelle - 1 fondo PVC Element on castors L. 40 cm 3 A drawers - 1 B drawers, 3 trays - 1 PVC bottom Elément mobile L. 40 cm sur cart avec 3 tiroirs A - 1 B 3 intérieurs de tiroirs - 1 fond en PVC Element auf Rollen, Breite 40 cm, 3 A Schubladen - 1 B Schublade, 3 Einsätze - 1 PVC Boden</p>	851	1023	996
Kg. 43				
<b>SRT5</b>	 <p><b>Elemento 2 cassetti A - 1 B - 2 C</b> 3 bacinelle - 2 fondi PVC 3 A drawers - 1 B drawer - 2 C drawers unit 3 trays - 2 PVC bottoms Elément 2 tiroirs A - 1 tiroir B - 2 tiroirs C 3 intérieurs de tiroirs - 2 fonds en PVC Element 2 A Schubladen - 1 B Schublade - 2 C Schubladen 3 Einsätze - 2 PVC Böden</p>	948	1160	1133
Kg. 33				
<b>SRT6</b>	 <p><b>Elemento 3 cassetti A - 2 B - 1 C</b> 4 bacinelle - 2 fondi PVC 3 A drawers - 2 B drawers - 1 C drawer unit 4 trays - 2 PVC bottoms Elément 3 tiroirs A - 2 tiroirs B - 1 tiroir C 4 intérieurs de tiroirs - 2 fonds en PVC Element 3 A Schubladen - 2 B Schubladen - 1C Schublade 4 Einsätze - 2 PVC Böden</p>	1085	1284	1257
Kg. 37				
<b>SRT7</b>	 <p><b>Elemento 5 cassetti A - 1 B - 1 C</b> 4 bacinelle - 3 fondi PVC 5 A drawers - 1 B drawer - 1 C drawer unit 4 trays - 3 PVC bottoms Elément 5 tiroirs A - 1 tiroir B - 1 tiroir C 4 intérieurs de tiroirs - 3 fonds en PVC Element 5 A Schubladen - 1 B Schublade - 1C Schublade 4 Einsätze - 3 PVC Böden</p>	1154	1360	1332
Kg. 39				
<b>SRT8</b>	 <p><b>Elemento 6 cassetti A - 2 B</b> 6 bacinelle - 2 fondi PVC 6 A drawers - 2 B drawers 6 trays - 2 PVC bottoms Elément 6 tiroirs A - 2 tiroirs B 6 intérieurs de tiroirs - 2 fonds en PVC Element 6 A Schubladen - 2 B Schubladen 6 Einsätze - 2 PVC Böden</p>	1174	1387	1360
Kg. 40				

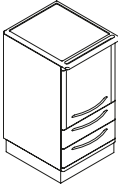
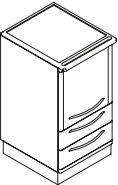
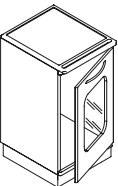
		Euro		
		laminato laminé laminé laminato	vetro glass verre glas	Corian Corian Corian Corian
<h3>SRTEM1</h3>  <p><b>Elemento 1 piano estraibile portastrumenti</b>            antina a scomparsa 2 cassetti B            1 bacinella - 1 fondo PVC            Unit with 1 extractable surgical instruments holder            disappearance door 2 B drawers            1 tray - 1 PVC bottom            Eléments 1 plan extractibles porte instruments - 2 tiroirs B            porte escamotable            1 intérieur de tiroir - 1 fond en PVC            Element mit 1 ausziehbarer Ablagefläche f. die Instrumente            Versenkbare kl. Tür – 2B Schubladen            1 Einsatz – 1 PVC Boden</p> <p>Kg. 34</p>		1167	1380	1353
<h3>SRTEM2</h3>  <p><b>Elemento 2 piani estraibili portastrumenti</b>            antina a scomparsa 2 cassetti B            1 bacinella - 1 fondo PVC            Unit with 2 extractable surgical instruments holders            disappearance door 2 B drawers            1 tray - 1 PVC bottom            Eléments 2 plans extractibles porte instruments - 2 tiroirs B            porte escamotable            1 intérieur de tiroir - 1 fond en PVC            Element mit 2 ausziehbarer Ablageflächen f. die Instrumente            Versenkbare kl. Tür – 2B Schubladen            1 Einsatz – 1 PVC Boden</p> <p>Kg. 34</p>		1236	1442	1415
<h3>SRZIRC</h3>  <p><b>Elemento 1 anta porta trays-zirc</b>            1 door element with dispenser for trays-zirc            Elément avec 1 porte et rayons internes pour trays-zirc            Element mit 1 Tür zur Trays-zirc Unterbringung</p> <p>Kg. 22</p>		1394	1607	1579

**ELEMENTI SU RUOTE SERIE PRESTIGE**

**ELEMENTS MOBILES SERIE PRESTIGE**

N.B.: Il peso degli elementi non include il piano top  
 N.B.: The weight of the elements doesn't include the worktop  
 N.B.: Le poids des éléments ne comprend pas le plan  
 Bitte beachten: Das Gewicht der Elemente beinhaltet nicht das Top

**ELEMENTS ON CASTORS PRESTIGE SERIE**

**BEISTELLELEMENTE SERIE PRESTIGE**

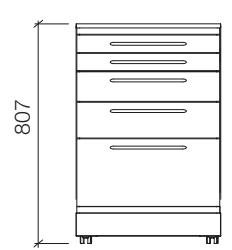
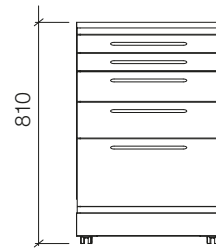
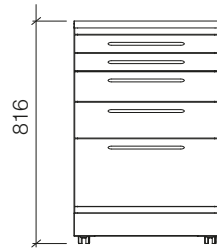

**LAMINATO**  
 LAMINATE  
 LAMINÉ  
 LAMINAT

**VETRO**  
 GLASS  
 VERRE  
 GLAS

**CORIAN**  
 CORIAN  
 CORIAN  
 CORIAN

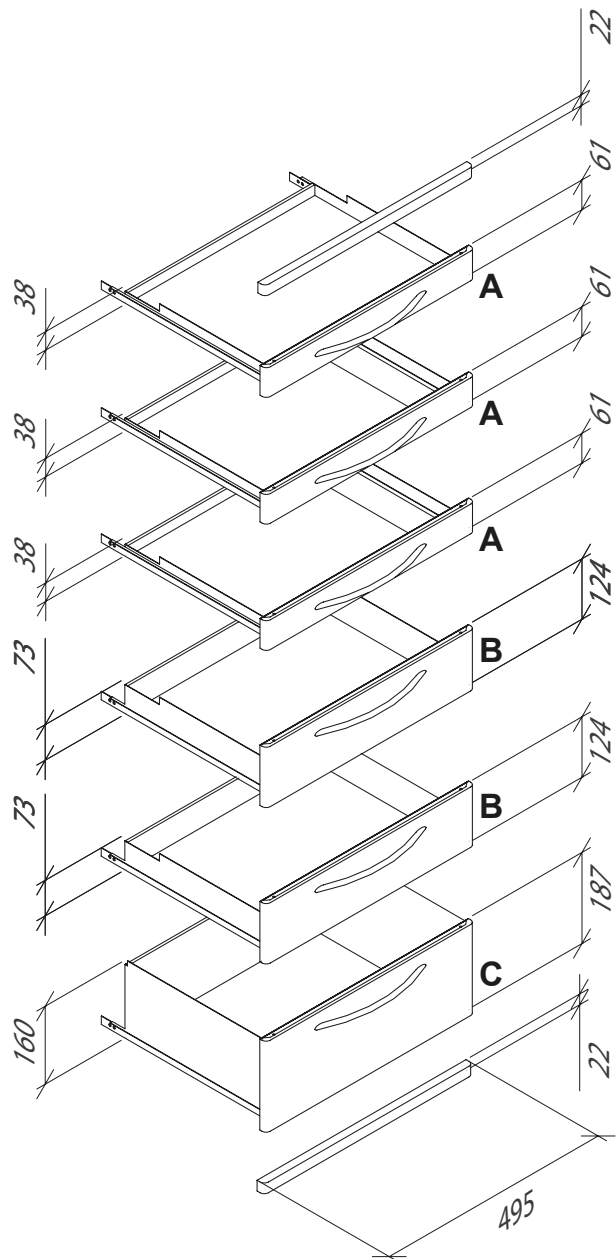
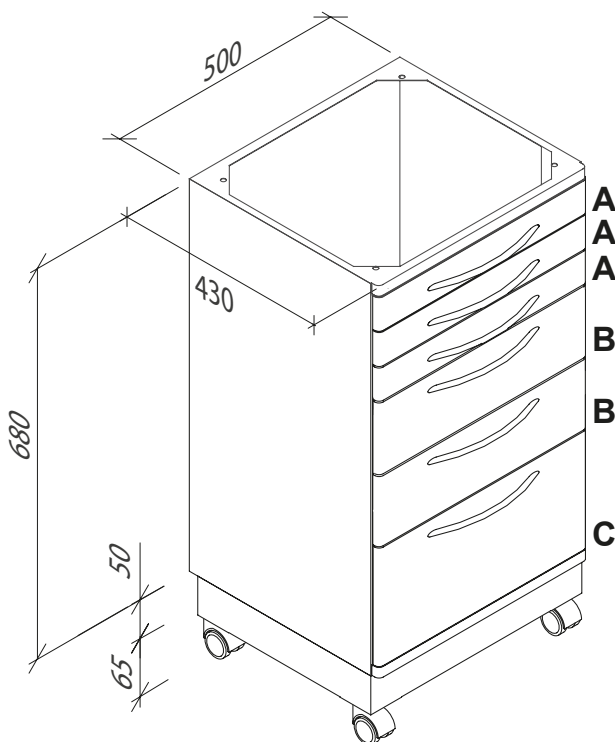

**ELEMENTI SU RUOTE L.50 CM**  
**ELEMENTS MOBILES L.50 CM**

**ELEMENTS ON CASTORS L.50 CM**  
**BEISTELLELEMENTE BR. 50 CM**

N.B.: Il prezzo è comprensivo di piano

N.B.: The price includes the worktop

N.B.: Dans le prix est inclus le plan

Bitte beachten: Der Preis beinhaltet die Arbeitsplatte

Euro

laminato laminated laminé laminat	vetro glass verre glas	Corian Corian Corian Corian
--	---------------------------------	--------------------------------------

**PRT5**

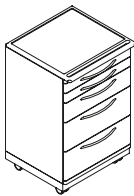

Kg. 33

**Elemento 2 cassetti A - 1 B - 2 C**  
 3 bacinelle - 2 fondi PVC  
 2 A drawers - 1 B drawer - 2 C drawers unit  
 3 trays - 2 PVC bottoms  
 Elément 2 tiroirs A - 1 B - 2 C  
 3 intérieurs de tiroirs - 2 fonds en PVC  
 Element 2 A Schubladen - 1B Schublade - 2 C Schubladen  
 3 Einsätze - 2 PVC Böden

948

1160

1147

**PRT6**

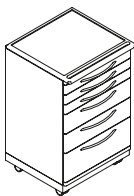

Kg. 34

**Elemento 3 cassetti A - 2 B - 1 C**  
 4 bacinelle - 2 fondi PVC  
 3 A drawers - 2 B drawers - 1 C drawer unit  
 4 trays - 2 PVC bottoms  
 Elément 3 tiroirs A - 2 B - 1 C  
 4 intérieurs de tiroirs - 2 fonds en PVC  
 Element 3 A Schubladen - 2 B Schubladen - 1C Schublade  
 4 Einsätze - 2 PVC Böden

1085

1291

1277

**PRT7**

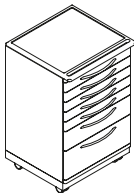

Kg. 37

**Elemento 5 cassetti A - 1 B - 1 C**  
 5 bacinelle - 2 fondi PVC  
 5 A drawers - 1 B drawer - 1 C drawer unit  
 5 trays - 2 PVC bottoms  
 Elément 5 tiroirs A - 1 B - 1 C  
 5 intérieurs de tiroirs - 2 fonds en PVC  
 Element 5 A Schubladen - 1B Schublade - 1C Schublade  
 5 Einsätze - 2 PVC Böden

1154

1360

1353

**PRT8**

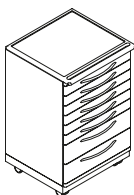

Kg. 38

**Elemento 6 cassetti A - 2 B**  
 5 bacinelle - 3 fondi PVC  
 6 A drawers - 2 B drawers unit  
 5 trays - 3 PVC bottoms  
 Elément 6 tiroirs A - 2 B  
 5 intérieurs de tiroirs - 3 fonds en PVC  
 Element 6 A Schubladen - 2B Schubladen  
 5 Einsätze - 3 PVC Böden

1174

1387

1373

**PRTEM2**

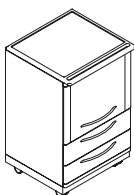

Kg. 34

**Elemento con 2 piani estraibili portastrumenti**  
 antina a scomparsa - 2 cassetti B  
 1 bacinella - 1 fondo PVC  
 Unit with 2 extractables surgical instruments holders  
 disappearance door 2B drawer  
 1 tray - 1 PVC bottom  
 Elément avec 2 plans extractibles porte-instruments  
 porte escamotable 2 tiroirs B  
 1 intérieur de tiroirs - 1 fond en PVC  
 Element mit 2 ausziehbaren Ablageflächen f. die Instrumente  
 Versenkbare kl. Tür - 2 B Schubladen  
 1 Einsatz - 1 PVC Boden

1236

1442

1428

PRESTIGE

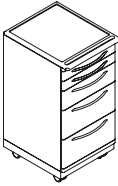
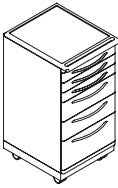
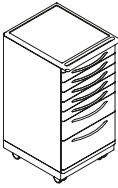
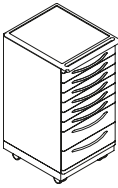
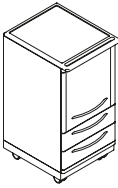
		Euro		
		laminato laminated laminé laminat	vetro glass verre glas	Corian Corian Corian Corian
<b>PSRT5</b>				
	<p><b>Elemento 2 cassetti A - 1 B - 2 C</b>            3 bacinelle - 2 fondi PVC            2 A drawers - 1 B drawer - 2 C drawers unit            3 trays - 2 PVC bottoms            Elément 2 tiroirs A - 1 B - 2 C            3 intérieurs de tiroirs - 2 fonds en PVC            Element 2 A Schubladen - 1 B Schublade - 2 C Schubladen            3 Einsätze - 2 PVC Böden</p>	948	1160	1133
Kg. 32				
<b>PSRT6</b>				
	<p><b>Elemento 3 cassetti A - 2 B - 1 C</b>            4 bacinelle - 2 fondi PVC            3 A drawers - 2 B drawers - 1 C drawer unit            4 trays - 2 PVC bottoms            Elément 3 tiroirs A - 2 B - 1 C            4 intérieurs de tiroirs - 2 fonds en PVC            Element 3 A Schubladen - 2 B Schubladen - 1C Schublade            4 Einsätze - 2 PVC Böden</p>	1085	1284	1257
Kg. 33				
<b>PSRT7</b>				
	<p><b>Elemento 5 cassetti A - 1 B - 1 C</b>            4 bacinelle - 3 fondi PVC            5 A drawers - 1 B drawer - 1 C drawer unit            4 trays - 3 PVC bottoms            Elément 5 tiroirs A - 1 B - 1 C            4 intérieurs de tiroirs - 3 fonds en PVC            Element 5 A Schubladen - 1 B Schublade - 1C Schublade            4 Einsätze - 3 PVC Böden</p>	1154	1360	1332
Kg. 35				
<b>PSRT8</b>				
	<p><b>Elemento 6 cassetti A - 2 B</b>            6 bacinelle - 2 fondi PVC            6 A drawers - 2 B drawers unit            6 trays - 2 PVC bottoms            Elément 6 tiroirs A - 2 B            6 intérieurs de tiroirs - 2 fonds en PVC            Element 6 A Schubladen - 2 B Schubladen            6 Einsätze - 2 PVC Böden</p>	1174	1387	1360
Kg. 37				
<b>PSRTEM1</b>				
	<p><b>Elemento 1 piano estraibile portastrumenti</b>            antina a scomparsa 2 cassetti B            1 bacinella - 1 fondo PVC            Unit with 1 extractable surgical instruments holder            disappearance door 2 B drawers - 1 tray - 1 PVC bottom            Elément 1 plan extractible porte - instruments            porte escamotable - 2 tiroirs B            1 interieur de tiroirs - 1 fond en PVC            Element mit 1 ausziehbarer Ablagefläche f. die Instrumente            Versenkbare kl. Tür - 2 B Schubladen            1 Einsatz - 1 PVC Boden</p>	1167	1373	1346
Kg. 33				

		Euro		
		laminato laminare laminé laminat	vetro glass verre glas	Corian Corian Corian Corian
<p><b>PSRTEM2</b></p>  <p>Kg. 34</p>	<p>Elemento 2 piani estraibili portastrumenti antina a scomparsa 2 cassette B 1 bacinella- 1 fondo PVC Unit with 2 extractables surgical instruments holder disappearance door 2 B drawers 1 tray- 1 PVC bottom Elément 2 plans extractibles porte - instruments porte escamotable - 2 tiroirs B 1 interieur de tiroirs - 1 fond en PVC Element mit 2 ausziehbaren Ablageflächen f. die Instrumente Versenkbare kl. Tür – 2 B Schubladen 1 Einsatz – 1 PVC Boden</p>	1236	1442	1415
	<p><b>PSRZIRC</b></p>  <p>Kg. 21</p>	<p>Elemento 1 anta porta trays-zirc 1 door element with dispenser for trays-zirc Elément avec 1 porte et rayons internes pour trays-zirc Element mit 1 Tür zur Trays-zirc Unterbringung</p>	1394	1607



**ELEMENTI SU RUOTE SERIE ELITE**  
**ELEMENTS MOBILES SERIE ELITE**

**ELEMENTS ON CASTORS ELITE SERIE**  
**BEISTELLELEMENTE SERIE ELITE**

N.B.: Il peso degli elementi non include il piano top  
 N.B.: The weight of the elements doesn't include the worktop  
 N.B.: Le poids des éléments ne comprend pas le plan  
 Bitte beachten: Das Gewicht der Elemente beinhaltet nicht das Top

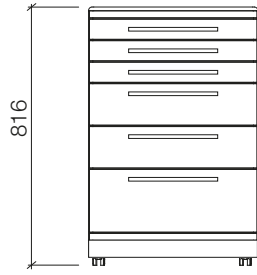

**LAMINATO**  
 LAMINATE  
 LAMINÉ  
 LAMINAT

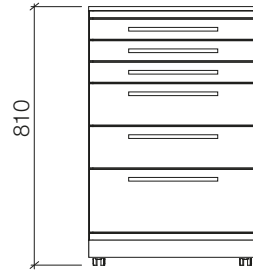

**VETRO**  
 GLASS  
 VERRE  
 GLAS

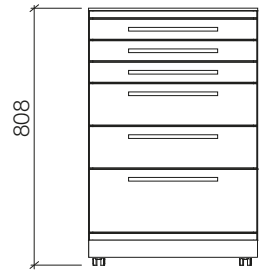

**CORIAN**  
 CORIAN  
 CORIAN  
 CORIAN

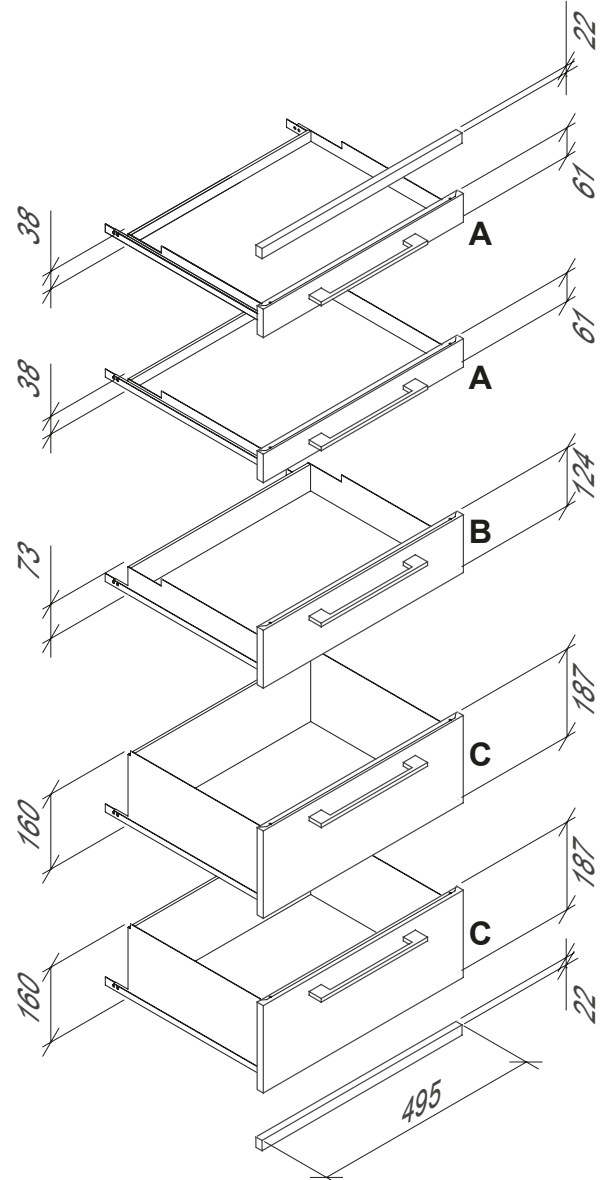
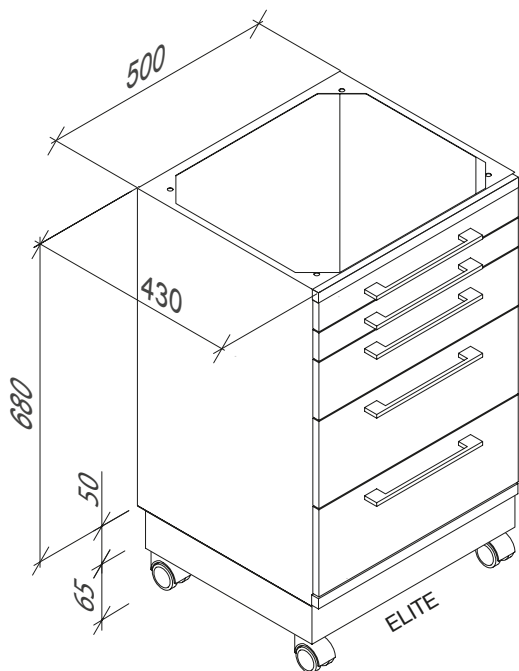
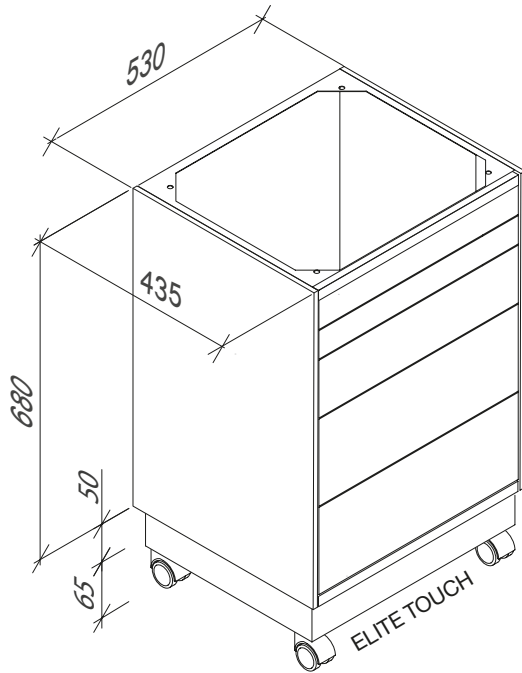

ELITE

**ELEMENTI SU RUOTE L.50 CM**  
**ELEMENTS MOBILES L.50 CM**

**ELEMENTS ON CASTORS L.50 CM**  
**BEISTELLELEMENTE BR. 50 CM**

N.B.: Il prezzo è comprensivo di piano - Mobili dotati di guide con rientro automatico

N.B.: The price includes the worktop - Elements with self-closing system of drawers

N.B.: Dans le prix est inclus le plan - Eléments avec système automatique de glissières

Bitte beachten: Der Preis ist inklusiv Arbeitsplatte -Elemente mit automatischem Selbsteinzug

Euro

laminato laminat laminé laminat	vetro glass verre glas	Corian Corian Corian Corian
--	---------------------------------	--------------------------------------

**ERT5**

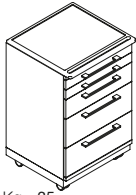

Kg. 35

**Elemento 2 cassetti A - 1 B - 2 C**  
 3 bacinelle - 2 fondi PVC  
 2 A drawers - 1 B drawer - 2 C drawers unit  
 3 trays -2 PVC bottoms  
 Elément 2 tiroirs A - 1 B - 2 C  
 3 intérieurs de tiroirs - 2 fonds en PVC  
 Element 2 A Schubladen – 1 B Schublade – 2 C Schubladen  
 3 Einsätze – 2 PVC Böden

1250

1456

1483

**ERT6**

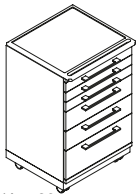

Kg. 36

**Elemento 3 cassetti A - 2 B - 1 C**  
 4 bacinelle - 2 fondi PVC  
 3 A drawers - 2 B drawers - 1 C drawer unit  
 4 trays - 2 PVC bottoms  
 Elément 3 tiroirs A - 2 B - 1 C  
 4 intérieurs de tiroirs - 2 fonds en PVC  
 Element 3 A Schubladen – 2 B Schubladen – 1C Schublade  
 4 Einsätze – 2 PVC Böden

1435

1648

1669

**ERT7**

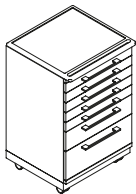

Kg. 39

**Elemento 5 cassetti A - 1 B - 1 C**  
 4 bacinelle - 3 fondi PVC  
 5 A drawers - 1 B drawer - 1 C drawer unit  
 4 trays - 3 PVC bottoms  
 Elément 5 tiroirs A - 1 B - 1 C  
 4 intérieurs de tiroirs - 3 fonds en PVC  
 Element 5 A Schubladen – 1 B Schublade – 1C Schublade  
 4 Einsätze – 3 PVC Böden

1572

1785

1813

**ERT8**

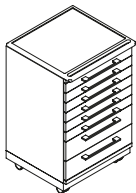

Kg. 41

**Elemento 6 cassetti A - 2 B**  
 5 bacinelle - 3 fondi PVC  
 6 A drawers - 2 B drawers unit  
 5 trays 1 - 3 PVC bottoms  
 Elément 6 tiroirs A - 2 B  
 5 intérieurs de tiroirs - 3 fonds en PVC  
 Element 6 A Schubladen – 2 B Schubladem  
 5 Einsätze – 3 PVC Böden

1655

1868

1895

**ERTEM2**

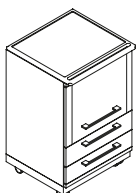

Kg. 35

**Elemento con 2 ripiani estraibili portastrumenti**  
 antina a scomparsa 2 cassetti B  
 1 bacinella - 1 fondo in PVC  
 Unit with 2 extractables surgical instruments holders  
 disappearance door - 2 B drawers  
 1 tray - 1 PVC bottom  
 Elément avec 2 plans extractibles porte instruments  
 porte escamotable 2 tiroirs B  
 1 interieur de tiroirs - 1 fond en PVC  
 Element mit 2 ausziehbaren Ablageflächen f. die Instrumente  
 Versenkbare kl. Tür – 2B Schubladen  
 1 Einsatz – 1 PVC Boden

1387

1593

1627

**ER100T5**

L.100 x P.43 x H.82

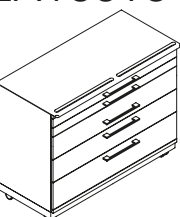

Kg. 70

**Elemento 2 cassetti A - 1 B - 2 C**  
 4 bacinelle - 3 fondi PVC  
 2 A drawers - 1 B drawer - 2 C drawers unit  
 4 trays 1 - 3 PVC bottoms  
 Elément 2 tiroirs A - 1 B - 2 C  
 4 intérieurs de tiroirs - 3 fonds en PVC  
 Element 2 A Schubladen – 1 B Schubladen - 2 C Schubladen  
 4 Einsätze – 3 PVC Böden

stratificato stratifié stratififié Schichtstoffarbeitsplatte	vetro glass verre glas	Corian Corian Corian Corian
---	---------------------------------	--------------------------------------

2389

2485

2457

Euro

MV

L. 100 x P.30 x H.50

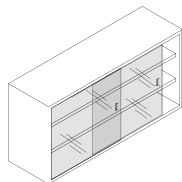

Kg. 35

**Pensile a vetri scorrevoli**

2 ripiani in cristallo

Wall unit with glass sliding plate and 2 glass shelves

Élément mural avec portes en verre coulissantes

2 rayons internes en verre

Hängeschränk mit Glasschiebetüren

2 Einlegeböden aus Glas

632

ST5

L. 50 x P.30 x H.50

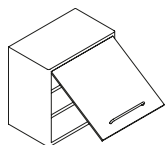

Kg. 12

**Pensile per sterilizzazione**

Sterilizing wall - unit

Élément mural pour stérilisation

Hängeschränk zur Sterilisation

652

ST52

L. 50 x P.30 x H.50

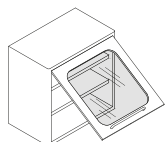

Kg. 12

**Pensile per sterilizzazione con porta in plexiglas**

Sterilizing wall unit with plexiglas door

Élément mural pour stérilisation avec porte en plexiglas

Hängeschränk zur Sterilisation mit Plexiglastür

721

ST4

L. 100 x P.30 x H.50

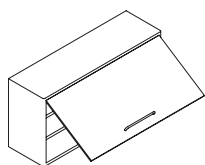

Kg. 26

**Pensile per sterilizzazione**

Sterilizing wall - unit

Élément mural pour stérilisation

Hängeschränk zur Sterilisation

838

ST42

L. 100 x P.30 x H.50

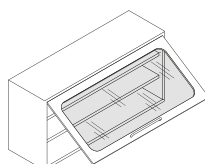

Kg. 24

**Pensile per sterilizzazione con porta in plexiglas**

Sterilizing wall-unit with plexiglas door

Élément mural pour stérilisation avec porte en plexiglas

Hängeschränk zur Sterilisation mit Plexiglastür

920

Euro

PDM

L. 100 x P. 30 x H. 50

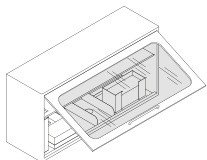

Kg. 25

Pensile per dispenser di prodotti monouso con porta in plexiglas  
Wall unit for disposables with plexiglas door  
Distributeur mural pour produits jetables avec porte en plexiglass  
Hängeschrank für Spender von Einwegprodukten mit plexiglastür

1057

PDM2

L. 100 x P. 30 x H. 50

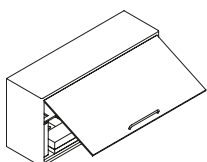

Kg. 25

Pensile per dispenser di prodotti monouso  
Wall unit for disposables  
Distributeur mural pour produits jetables  
Hängeschrank für Spender von Einwegprodukten

996

Euro

PDMP

L.53 x P.13.5 x H.53

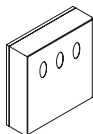

Kg. 12

**Gruppo igiene** con dispenser di salviette, guanti, bicchieri, mascherine e distributore di sapone automatico.  
Hanging unit equipped with automatic soap, napkins gloves, mask and glass distributors  
Groupe hygiène équipé de distributeurs de savon automatique, serviettes, gants, gobelets et distributeur de savon  
Hygieneeinheit mit Spender für Reinigungstücher, Handschuhe, Becher, Masken und automatischen Seifenspender.

817

PDMP2

L.53 x P.13.5 x H.53

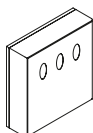

Kg. 12

**Gruppo igiene** con dispenser di salviette, guanti, bicchieri e mascherine.  
Hanging unit equipped with napkins, gloves, mask and glass distributors  
Groupe hygiène équipé de distributeurs de serviettes, gants, masques et gobelets  
Hygieneeinheit mit Spender für Reinigungstücher, Handschuhe, Becher und Masken.

659

PDMPS

L.53 x P.13.5 x H.53

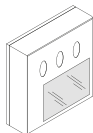

Kg. 12

**Gruppo igiene** con dispenser di salviette, guanti, bicchieri, mascherine, distributore di sapone automatico e specchio.  
Hanging unit equipped with automatic soap, napkins, gloves, mask, glass distributors and mirror.  
Groupe hygiène équipé de distributeurs de savon automatique, serviettes, gants, masques, gobelets et miroir  
Hygieneeinheit mit Spender für Reinigungstücher, Handschuhe, Becher, Masken, automatischen Seifenspender und Spiegel.

872

ILL

min 50 cm - max 200 cm

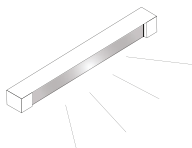

**Impianto di illuminazione led** da applicare sotto il pensile: al metro lineare  
Lighting system under the wall unit: per meter  
Système d'éclairage sous l'élément mural: au mètre  
Beleuchtungssystem unter dem Hängeschränku: pro Meter

213

Euro

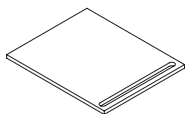

Piano con maniglia per servomobile  
Top with handle for mobile element  
Plan avec poignée pour élément sur roulettes  
Platte mit Griff für Beistellelement

**LAMINATO**  
LAMINATE - LAMINÉ - LAMINAT

L.40 - Kg. 4

**AL40**

137

**STRATIFICATO**  
STRATIFIED - STRATIFIÉ - SCHICHTSTOFFARBEITSPLATTE

L.40 - Kg. 4

**ASTR40**

240

**CORIAN**

L.40 - Kg. 5

**ACO40**

261



Piano in vetro con maniglia per servomobile  
Glass top with handle for mobile element  
Plan en verre avec poignée pour élément sur roulettes  
Glasplatte mit Griff für Beistellelement

**VETRO**  
GLASS- VERRE - GLAS

L.40 - Kg. 18

**AVE40**

309

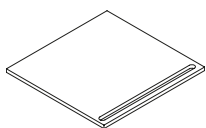

Piano con maniglia per servomobile  
Top with handle for mobile element  
Plan avec poignée pour élément sur roulettes  
Platte mit Griff für Beistellelement

**LAMINATO**  
LAMINATE - LAMINÉ - LAMINAT

L.50 - Kg. 6

**AL50**

151

**STRATIFICATO**  
STRATIFIED - STRATIFIÉ - SCHICHTSTOFFARBEITSPLATTE

L.50 - Kg. 6

**ASTR50**

260

**CORIAN**

L.50 - Kg. 5.5

**ACO50**

288



Piano in vetro con maniglia per servomobile  
Glass top with handle for mobile element  
Plan en verre avec poignée pour élément sur roulettes  
Glasplatte mit Griff für Beistellelement

**VETRO**  
GLASS- VERRE - GLAS

L.50 - Kg. 19

**AVE50**

330

Euro / ml

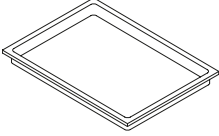
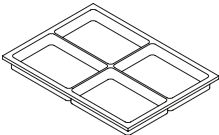
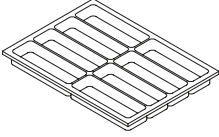
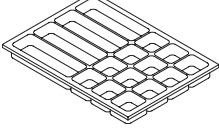
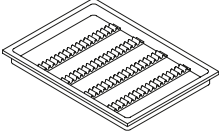
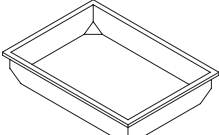
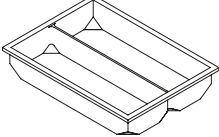
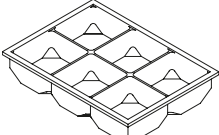
	<b>BA-A01</b> <i>L.45 x P.32 x H.3.7</i> <b>Bacinella 1 settore per cassetto piccolo</b> 1 sector basin for small drawer Intérieur 1 secteur pour petit tiroir Einsatz, 1 Unterteilung für kleine Schublade	25
	<b>BA-A04</b> <i>L.45 x P.32 x H.3.7</i> <b>Bacinella 4 settori per cassetto piccolo</b> Basin 4 sectors for small drawer Intérieur à 4 secteurs pour petit tiroir Einsatz, 4 Unterteilungen für kleine Schublade	25
	<b>BA-A08</b> <i>L.45 x P.32 x H.3.7</i> <b>Bacinella 8 settori per cassetto piccolo</b> Basin 8 sectors for small drawer Intérieur à 8 secteurs pour petit tiroir Einsatz, 8 Unterteilungen für kleine Schublade	25
	<b>BA-A16</b> <i>L.45 x P.32 x H.3.7</i> <b>Bacinella 16 settori per cassetto piccolo</b> Basin 16 sectors for small drawer Intérieur à 16 secteurs pour petit tiroir Einsatz, 16 Unterteilungen für kleine Schublade	25
	<b>BA-A36</b> <i>L.45 x P.32 x H.3.7</i> <b>Bacinella a rastrelliera per cassetto piccolo</b> Rack low basin for small drawer Intérieur avec ratelier pour petit tiroir Einsatz mit Instrumentenablage für kleine Schublade	25
	<b>BA-B01</b> <i>L.45 x P.32 x H.8</i> <b>Bacinella 1 settore per cassetto medio</b> 1 sector hight basin for medium drawer Intérieur à 1 secteur pour tiroir moyen Einsatz, 1 Unterteilung für mittelgroße Schublade	30
	<b>BA-B02</b> <i>L.45 x P.32 x H.8</i> <b>Bacinella 2 settori per cassetto medio</b> 2 sectors hight basin for medium drawer Intérieur à 2 secteurs pour tiroir moyen Einsatz, 2 Unterteilungen für mittelgroße Schublade	30
	<b>BA-B06</b> <i>L.45 x P.32 x H.8</i> <b>Bacinella 6 settori per cassetto medio</b> 6 sectors hight basin for medium drawer Intérieur à 6 secteurs pour tiroir moyen Einsatz, 6 Unterteilungen für mittelgroße Schublade	30

**BACINELLE L.35 cm****INTERIEURS DES TIROIRS L. 35 cm****BASINS L.35 cm****EINSÄTZE L.35 CM**

N.B.: Per modelli ST e SR

N.B.: For ST and SR models

N.B.: Pour model ST et SR

Bitte beachten: Für die Modelle ST und SR

Euro

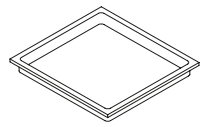
**BA-AS01***L.35.2 x P.32.7 x H.3.5***Bacinella 1 settore per cassetto piccolo**

1 sector basin for small drawer

intérieur 1 secteur pour petit tiroir

Einsatz, 1 Unterteilung für kleine Schublade

25

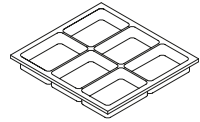
**BA-AS06***L.35.2 x P.32.7 x H.3.5***Bacinella a 6 settori per cassetto piccolo**

6 sectors basin for small drawer

Intérieur à 6 secteurs pour petit tiroir

Einsatz, 6 Unterteilungen für kleine Schublade

25

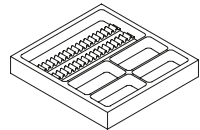
**BA-ASRASTR***L.35.2 x P.32.7 x H.3.5***Bacinella rastrelliera per cassetto piccolo**

Basin for small drawer

Intérieur pour petit tiroir

Einsatz mit Instrumentenablage für kleine Schublade

25

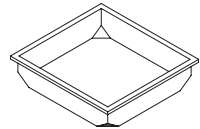
**BA-BS01***L.35.2 x P.32.7 x H.78***Bacinella 1 settore per cassetto medio**

1 sector basin for medium drawer

intérieur 1 secteur pour tiroir moyen

Einsatz, 1 Unterteilung für mittelgroße Schublade

30

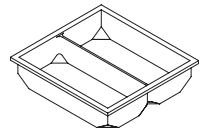
**BA-BS02***L.35.2 x P.32.7 x H.78***Bacinella 2 settori per cassetto medio**

2 sectors basin for medium drawer

Intérieur à 2 secteurs pour tiroir moyen

Einsatz, 2 Unterteilungen für mittelgroße Schublade

30



Euro

## C2R

L.55 x P.43 x H.82

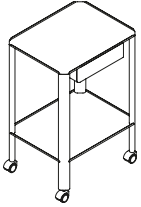

Kg. 20

**Carrello 2 ripiani e cassetto**  
 Trolley with 2 shelves and drawer  
 Chariot avec 2 étagères et 1 tiroir  
 Rollwagen 2 Ablageflächen und 1 Schublade

350

## C2RCHP

L.42 x P.34 x H.88

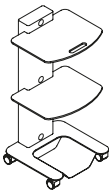

Kg. 16

**Carrello chirurgico piccolo 2 ripiani vetro**  
 3 prese di corrente  
 Small surgical trolley with 2 glass shelves and 3 current taps  
 Chariot chirurgie petit avec 2 étagères en verre  
 3 prises de courant  
 Kleiner chirurgischer Rollwagen 2 Glasablageflächen  
 3 Steckdosen

673

## C2RCHM

L.48 x P.38 x H.92

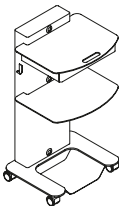

Kg. 40

**Carrello chirurgico grande**  
 2 ripiani vetro - 1 cassetto e 3 prese di corrente  
 Maxi surgical trolley  
 2 glass shelves - 1 drawer and 3 current taps  
 Chariot chirurgie maxi  
 2 étagères en verre - 1 tiroir et 3 prises de courant  
 Großer chirurgischer Rollwagen  
 2 Glasablageflächen - 1 Schublade und 3 Steckdosen

1195

Euro

### C3R

L.40 x P.45 x H.79

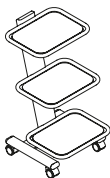

Kg. 12

**Carrello 3 ripiani con 2 prese universali**  
 Trolley with 3 shelves and 2 current taps  
 Chariot 3 étagères et 2 prises normalisées  
 Rollwagen 3 Ablageflächen mit 2 Universalsteckdosen

343

### C3RK

L.48 x P.40 x H.80

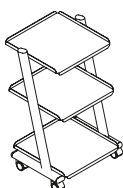

Kg. 11

**Carrello 3 ripiani con 3 prese universali**  
 Trolley with 3 shelves and 3 current taps  
 Chariot 3 étagères et 3 prises de courant  
 Rollwagen 3 Ablageflächen mit 3 Universalsteckdosen

247

### C3RK1

L.48 x P.40 x H.80

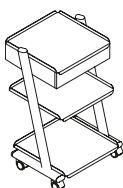

Kg. 16.5

**Carrello 3 ripiani con 3 prese universali e 1 cassetto**  
 3 shelves trolley with 1 drawer and 3 current taps  
 Chariot 3 étagères avec 3 prises de courant et 1 tiroir  
 Rollwagen 3 Ablageflächen mit 3 Universalsteckdosen und 1 Schublade

439

### C2RK3

L.48 x P.40 x H.80

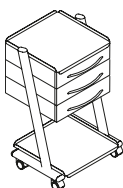

Kg. 20

**Carrello 2 ripiani con 3 prese universali e 3 cassetti**  
 2 shelves trolley 3 current taps and 3 drawers  
 Chariot 2 étagères avec 3 prises de courant et 3 tiroirs  
 Rollwagen 2 Ablageflächen mit 3 Universalsteckdosen und 3 Schubladen

522

### C3RV

L.49 x P.37 x H.79.5

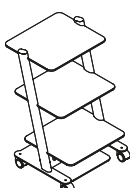

Kg. 23

**Carrello 3 ripiani in vetro con 2 prese universali**  
 Trolley with 3 glass shelves and 2 current taps  
 Chariot 3 étagères en verre et 2 prises normalisées  
 Rollwagen 3 Glasablageflächen mit 2 Universalsteckdosen

673

Euro

## C3RV MAXI

L.66 x P.54 x H.79.5

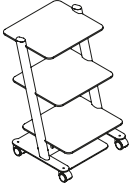

Kg. 30

**Carrello maxi 3 ripiani in vetro con 2 prese universali**  
Maxi trolley with 3 glass shelves and 2 current taps  
Chariot 3 étagères en verre et 2 prises normalisées  
Großer Rollwagen 3 Glasablageflächen mit 2 Universalsteckdosen

1037

## C3RT

L.40 x P.54 x H.93

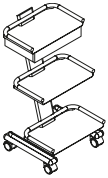

Kg. 18

**Carrello portastrumenti 3 ripiani**  
1 cassetto con 2 prese universali  
Instruments holder trolley with 3 shelves  
1 drawer and 2 current taps  
Chariot porte instruments 3 étagères  
1 tiroir et 2 prises de courant  
Rollwagen Instrumentenhalter 3 Ablageflächen  
1 Schublade und 2 Universalsteckdosen

632

## C3RT2

L.40 x P.54 x H.93

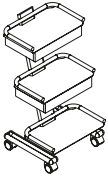

Kg. 18

**Carrello portastrumenti 3 ripiani**  
2 cassetti con 2 prese universali  
Instrument trolley with 3 shelves,  
2 drawers and 2 current taps  
Chariot porte instruments 3 étagères  
2 tiroirs et 2 prises de courant  
Rollwagen Instrumentenhalter 3 Ablageflächen  
2 Schubladen und 2 Universalsteckdosen

735

## C3RTM

L.50 x P.54 x H.93

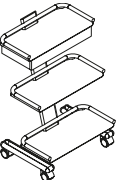

Kg. 23

**Carrello portastrumenti 3 ripiani**  
1 cassetto con 2 prese universali  
Instruments holder trolley with 3 shelves  
1 drawer and 2 current taps  
Chariot porte instruments 3 étagères  
1 tiroir et 2 prises de courant  
Rollwagen Instrumentenhalter 3 Ablageflächen  
1 Schublade und 2 Universalsteckdosen

632

Euro

## C3RTM2

L.50 x P.54 x H.93

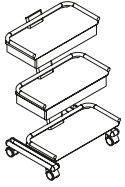

Kg. 23

**Carrello portastrumenti 3 ripiani**  
2 cassetti con 2 prese universali  
Instrument trolley with 3 shelves,  
2 drawers and 2 universal current taps  
Chariot porte instruments 3 étagères  
2 tiroirs et 2 prises de courant  
Rollwagen Instrumentenhalter 3 Ablageflächen  
2 Schubladen und 2 Universalsteckdosen

735

## C3RQ

L.35 x P.45 x H.78

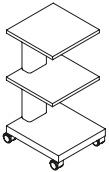

Kg. 14

**Carrello portastrumenti 3 ripiani**  
con 2 prese universali  
Instruments holder trolley with 3 shelves  
2 current taps  
Chariot porte instruments 3 étagères  
2 prises de courant  
Rollwagen Instrumentenhalter 3 Ablageflächen  
2 Universalsteckdosen

439

## C4RQ

L.56 x P.50 x H.150

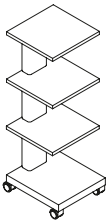

Kg. 15

**Carrello 4 ripiani e 3 prese di corrente**  
Trolley with 4 shelves and 3 current taps  
Chariot avec 4 étagères et 3 prises de courant  
Rollwagen 4 Ablageflächen und 3 Steckdosen

508

## KITTUBI

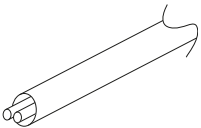

**Kit di tubi per connessione aria/acqua per carrello**  
Air/water hose kit for trolley  
Kit tuyaux air/eau pour chariot  
Schlauch-Set für Luft-/Wasseranschluss beim Rollwagen

206

Euro



Kit 5 ruote per seggiolino (nere o grigie)  
5 castors kit for chair (black or grey)  
Kit 5 roulettes pour siège (noir or gris)  
Set mit 5 Rädern für Stuhl (Schwarz oder Grau)

49

Euro

## DSPDMP

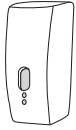

**Distributore automatico di sapone per PDMP**  
Automatic soap distributor for PDMP  
Distributeur manuel de savon pour PDMP  
Automatischer Seifenspender für PDMP

247

Euro

## MINOX

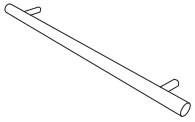

**Maniglia in acciaio INOX**  
Stainless steel handle  
Poignée en inox  
Edelstahlgriff

27

## MAR



**Maniglia ad arco**  
Arc handle  
Poignée en arc  
Bogenförmiger Griff

Alluminio  
Aluminium  
Aluminium

23

finitura INOX  
INOX finishing  
finissage INOX  
Oberflächenfinish  
STAHL

27

## MQ

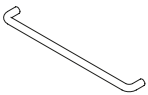

**Maniglia quadra**  
Rectangular handle  
Poignée carrée  
Rechteckiger Griff

23

## MARE

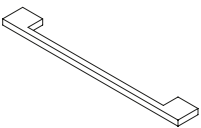

**Maniglia rettangolare modello Elite**  
Rectangular handle Elite model  
Poignée carrée Elite  
Rechteckiger Griff Mod. ELITE

23

## MARE2

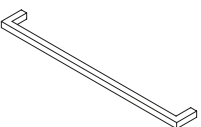

**Maniglia rettangolare modello Elite (L. 40 cm)**  
Rectangular handle Elite model (L. 40 cm)  
Poignée carrée Elite (L. 40 cm)  
Rechteckiger Griff Mod. ELITE L.40 cm

36

Euro

## TABEXT2

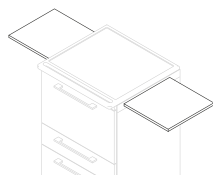

### Supplemento per kit doppia tavoletta estraibile in acciaio INOX

Additional charge for kit double side extractable inox tablet  
Supplément pour kit double tablette latérale extractible en INOX  
Zuschlag für Doppelt Ausziehbare Ablage aus EDEL-STAHLE

+ 439

## FPVC

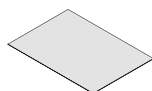

### Fondo in PVC

PVC bottom  
Fond en PVC  
PVC Boden

12

## KCS

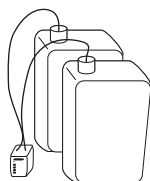

### Kit taniche di carico e scarico,

pedale e trasformatore per pompa di pescaggio  
Loading and unloading water tank kit,  
pedal and transformer for suction pump  
Kit de reservoirs de chargement et déchargement d'eau,  
pédale et transformateur pour pompe d'aspiration  
Kanister-Set zum Befüllen und Ablassenwasser,  
Pedal und Transformator für Saugpumpe

288



Euro

## SERR



**Serratura per cassetto o antina**  
Lock for drawer or door  
Serrure pour porte ou tiroir  
Schlüssel für Schublade oder Tür

89

## SERR2



**Serratura centralizzata per cassetti**  
Centralized lock for drawers  
Serrure centralisée pour tiroir  
Zentrales Schlüsselwerk für Schubladen

227

## CAPT

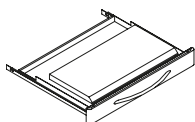

**Supplemento cassetto A porta tastiera**  
Additional charge for drawer A - keyboard - holder  
Supplement pour tiroir A porte-clavier  
Zuschlag für A Schublade mit Tastaturhalter

144

Euro

## FRORI

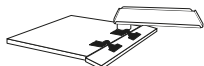

**Supplemento per frontale "A" a ribalta con ripiano estraibile porta trays**

Additional charge for flip drawer front with pull out shelf and trays-holder bracket

Supplément pour façade A a battante avec étagère extractible pour la dépose de plateaux.

Zuschlag für kippbare Vorderseite mit ausziehbarer Ablagefläche und Tray-Ablage

549

## BOCPC



**Boccola passacavo**

Insert for cable

Galoche

Kabeldurchgang

22

Euro

## RIC3RV

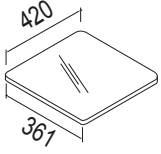

**Ripiano C3RV**  
Glass shelf for C3RV  
Étagère en verre pour C3RV  
Glas Einlegeboden für C3RV

48

## RIP1

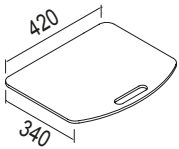

**Ripiano C2RCHP con maniglia**  
Glass shelf for C2RCHP with handle  
Étagère en verre pour C2RCHP avec poignée  
Glas Einlegeboden mit Griff für C2RCHP

80

## RIP2

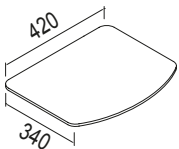

**Ripiano C2RCHP senza maniglia**  
Glass shelf for C2RCHP without handle  
Étagère en verre pour C2RCHP sans poignée  
Glas Einlegeboden ohne Griff für C2RCHP

53

## RIP3

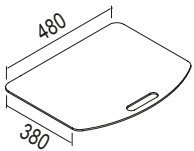

**Ripiano C2RCHM con maniglia**  
Glass shelf for C2RCHM with handle  
Étagère en verre pour C2RCHM avec poignée  
Glas Einlegeboden mit Griff für C2RCHM

100

## RIP4

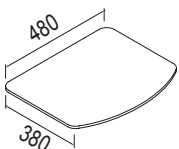

**Ripiano C2RCHM senza maniglia**  
Glass shelf for C2RCHM without handle  
Étagère en verre pour C2RCHM sans poignée  
Glas Einlegeboden ohne Griff für C2RCHM

73

Euro

## KITRUOTE



### Kit 4 ruote con e senza freno per carrello e servomobile

Kit 4 castors with and without brake kit for trolley and mobile element

Kit 4 roulettes avec et sans frein pour chariot et element mobile

Set mit 4 gebremsten und ungebremsten Rädern für Rollwagen und Beistellelemente

49

- 1) I prezzi degli articoli, resi noti dal presente listino si intendono “al pubblico” I.V.A. esclusa. Per fatture di importo inferiore a 150,00 € verranno addebitate le spese per l'emissione dell'effetto bancario.
- 2) Tutte le ordinazioni si intendono assunte salvo il venduto e salvo buone informazioni.
- 3) La merce viaggia a rischio e pericolo del committente anche se venduta franco destino.
- 4) La consegna si intende fatta al compratore, a tutti gli effetti, all'atto dell'uscita della merce dai nostri magazzini, venendo con cio' a cessare ogni Nostra responsabilità
- 5) Non rispondiamo di conseguenza dei ritardi, disguidi, perdite, avarie comunque derivanti dal mezzo di trasporto, né dalla scelta di esso, i reclami contro il vettore devono essere esercitati dal destinatario.
- 6) ZILFOR si riserva la facoltà di evadere le commissioni anche in più riprese.
- 7) I termini di consegna assumono per ZILFOR valore puramente indicativo e non vincolante.
- 8) Il mancato arrivo delle materie prime adatte va considerato come caso di forza maggiore. In tutti i casi di forza maggiore ZILFOR ha la facoltà di annullare o ritardare l'esecuzione della commissione senza che il committente possa pretendere alcun Indennizzo.
- 9) Non si accettano reclami se non fatti per lettera raccomandata entro tre giorni dall'arrivo della merce. Per nessun motivo il compratore potrà rifiutarsi allo svincolo delle merci in arrivo; le soste e i conseguenti danni causati dal suo eventuale rifiuto saranno a completo suo carico.
- 10) La garanzia su eventuali difetti di materiale e fabbricazione segue le disposizioni legislative ed ha una validità di mesi 24 decorrenti dalla data di consegna (e data DDT).
- 11) Non si accettano ritorni di merce se non sono stati previamente autorizzati da ZILFOR. Il ritorno viene effettuato solo se la merce è imballata in modo da garantire il trasporto senza ulteriori danni e dovrà essere dotata di regolare documento di accompagnamento, ove dovrà risultare per ciascun articolo il tipo, il colore, la quantità, il numero e la data della fattura di acquisto. L'accredito della merce ritirata viene fatto in base ai prezzi d'acquisto e tenendo conto dello stato di ciascun elemento reso, valutato a insindacabile giudizio del Nostro Ufficio Tecnico.
- 12) Anche in caso di contestazione di qualsiasi genere e segnalata nel modo richiesto, permane il diritto per ZILFOR di richiedere l'integrale pagamento della fornitura.
- 13) Per qualunque caso di contestazione unico foro competente è quello di Treviso.
- 14) In caso di mancato pagamento, salvo ogni nostro diritto, decorrerà l'interesse commerciale.
- 15) Il mancato pagamento di una scadenza o la mutata situazione del compratore daranno diritto a ZILFOR di annullare senz'altro ogni contratto esistente.
- 16) La merce rimane fino al suo pagamento di proprietà di ZILFOR che ha la facoltà di ritirarla.
- 17) Gli elementi fuori serie per dimensioni, per materiale e/o colore devono essere preventivamente accettati dal nostro Ufficio Tecnico sia per la possibilità del tempo di realizzo, sia per la determinazione del prezzo di vendita.
- 18) ZILFOR declina ogni responsabilità per l'errato montaggio in loco dei suoi articoli non eseguiti dal proprio personale.
- 19) La conformità “al campione” sia per la prima che per le successive forniture, non va intesa in senso restrittivo giacché sussistono margini di tolleranza di regola riconosciuti per i vari materiali impiegati.
- 20) ZILFOR si riserva il diritto di variare in qualsiasi dettaglio gli articoli e i prezzi descritti nel presente listino senza doverne dare preavviso alla clientela.
- 21) Si prega di citare negli ordini il codice completo di ogni prodotto e il relativo prezzo.
- 22) I depliant in circolazione hanno carattere puramente illustrativo e, pertanto, ZILFOR declina ogni responsabilità per eventuali inesattezze di stampa o per errate indicazioni sulle caratteristiche del prodotto.
- 23) Le consegne sul territorio nazionale relative a ordini di importo totale netto inferiore a € 800,00 vengono effettuate esclusivamente in porto assegnato. Per cifre superiori il trasporto sarà trattato a parte, indipendentemente dalle modalità di addebito, la merce si intende consegnata al piano cortile, salvo diverso accordo.
- 24) I prezzi riportati non comprendono il montaggio che, qualora richiesto, sarà sempre quotato a parte.

**1) The prices of the articles are indicated in this price list and are the “retail prices” excluding VAT.**

- 2) All orders are accepted sale excepted and under usual reserve.
- 3) The goods travel at the buyer's risk even if sold delivery free.
- 4) Delivery is made, to all effects, to the buyer at the moment the goods leave our warehouses, all liability for us thus cease from that moment on.
- 5) We cannot be held responsible for the consequences due to delays, miscarriages, losses, damages resulting from the means of transport, neither from the choice of the same; complaints about the carrier must be made by the consignee.
- 6) ZILFOR reserves the right to handle orders also in several instalments
- 7) For ZILFOR, the terms of delivery are given purely as an indication and are not binding
- 8) Failure of suitable raw materials to arrive is considered as Force Majeure. In all cases of Force Majeure, ZILFOR has the right to cancel or delay the completion of orders, without the buyer having the right to claim compensation.
- 9) No complaints are accepted unless sent by registered letter within 3 days from the arrival of the goods. For no reason whatsoever may the buyer refuse to clear the incoming goods, while the demurrage and consequent damage caused by his eventual refusal shall be fully charged to him.
- 10) The guarantee of possible defects about material or concerning the manufacturing follows lowgiving dispositions and has 24 month's validity from delivery date (or from transport document).
- 11) Returned goods will not be accepted unless previously authorised by ZILFOR. Returns are only accepted if the goods are packet in such a way as to guarantee carriage without further damage and shall have a regular packing list, in which the type, colour, quantity, number and date of purchase invoice for each article shall be specified. Credit for the returned goods is made on the basis of the purchase prices and taking into consideration the state of each returned element, assessed by our Technical Office, whose decision is final.
- 12) Also in the case of contestation of any kind whatsoever and notified in the request manner, ZILFOR still has the right to ask for full payment of the supply.
- 13) The only court of competent jurisdiction for any dispute whatsoever is Treviso.
- 14) In the event of non-payment, all our rights being applicable, commercial interest shall be applied.
- 15) Non-payment at a due date or the changed situation of the buyer shall give ZILFOR the right to cancel without further delay all existing agreements.
- 16) The goods remain the property of ZILFOR, who have the right to withdraw them, until full payment is made.
- 17) The elements wich are custom-made with regard to dimensions, material and/or colour must be previously accepted by our Technical Office with regards to feasibility, time required for production and calculation of the sale price.
- 18) ZILFOR cannot be helresponsible for incorrect assembly of its article on site unless carried out by its own personnel.
- 19) Conformity “to the sample” both for first and subsequent supplies should not be interpreted in a restrictive way, since there are normally recognized margins of tolerance for the various materials used.
- 20) ZILFOR reserves the right to alter any detail of this articles and the prices indicated in this price list without advising its customers.
- 21) When ordering you are requested to quote the complete code number of each product and the relative price.
- 22) Brochures have the sole purpose of illustrating the product and ZILFOR therefore cannot be held responsible for any printing inaccuracies or wrong indications regarding product specifications.
- 23) Deliveries on national territory relating to orders with a net total amount of less than € 800,00 must be made exclusively carriage unpaid. For higher amounts, carriage shall be negotiated separately, independently of the methods of debiting, the goods being delivered only to the ground floor, unless otherwise agreed.
- 24) The listed price do not include assembly which, when requested, is always quoted separately.

**1) Les prix des articles sont divulgués par cette liste des prix; ils s'entendent "au public"; avec TVA française.**

- 2) Les commandes s'entendent acceptées, sauf le vendu et sauf bons renseignements.
- 3) La marchandise voyage aux risques et périls de l'acquéreur, même si vendue franco à destination
- 4) La livraison s'entend effectuée à l'acquéreur, à tous les effets, au moment de la sortie de la marchandise de nos magasins; cessant par cela toute responsabilité de notre part.
- 5) Nous ne répondons pas des conséquences causées par les retards, erreurs, pertes ou avaries dérivant aussi bien du moyen de transport que de la choix de celui-là; toute réclamation au transporteur doit être exercée par le destinataire.
- 6) ZILFOR se réserve le droit d'exécuter également les commandes même par plusieurs livraisons partielles.
- 7) Les conditions de livraison ont pour ZILFOR une valeur purement indicative et non contraignante.
- 8) La non-livraison des matières premières appropriées constitue un cas de force majeure. Dans tous les cas de force majeure ZILFOR a la faculté d'annuler ou de retarder l'exécution de la commande sans que le client puisse exiger une indemnité.
- 9) On n'accepte autre réclamation que par lettre recommandée dans un délai trois jours dès réception de la marchandise. Pour aucune raison l'acheteur ne pourra se refuser d'accepter les marchandises entrantes; les arrêts et les dommages conséquents causés par un refus éventuel seront entièrement à sa charge.
- 10) La garantie concernant éventuels défauts du matériel ou de fabrication suite les dispositions législatives et a une validité de 24 mois à partir de la date de livraison ( ou date document de transport).
- 11) Aucune marchandise de retour ne sera acceptée si ZILFOR ne l'a pas autorisé préalablement. Le retour sera effectué seulement si la marchandise est emballée de façon à garantir son transport sans dommages ultérieurs. Elle devra être accompagnée du document d'accompagnement régulier, où l'on mentionnera le type, la couleur, la quantité, le numéro et la date de la facture d'achat de chaque article. L'avoir relatif à la marchandise retirée sera calculé sur la base des prix d'achat, en prenant en considération l'état de chaque élément rendu, évalué sur la base de la décision sans appel de notre Service Technique
- 12) Même en cas de contestation, de quelle que nature que ce soit, et signalée de la façon requise, ZILFOR garde également le droit de demander le paiement intégral de la commande.
- 13) Dans tous les cas de contestation le tribunal de Treviso est le seul compétent.
- 14) En cas de non-paiement, sauf tous nos droits, on va calculer l'intérêt commercial.
- 15) Le non-paiement d'une échéance ou la situation changée de l'acquéreur donneront à ZILFOR le droit d'annuler tout contrat existant.
- 16) Jusqu'à son paiement, la marchandise reste propriété de ZILFOR qui a faculté de la retirer.
- 17) Tout élément hors série par dimensions, matériaux et ou couleur doit être accepté préalablement par notre Service Technique en ce qui concerne la possibilité du temps de réalisation, et la détermination du prix de vente.
- 18) ZILFOR décline toute responsabilité pour l'incorrect montage sur place de ses articles qui n'a pas été effectué par son personnel.
- 19) La conformité "à l'échantillon", aussi bien pour la première fourniture que pour toute fourniture suivante, ne s'entend pas dans un sens restrictif, puisque il y a des marges de tolérance qui en règle générale sont reconnus aux différents matériaux employés.
- 20) ZILFOR se réserve le droit de modifier tout détail de ses articles et les prix indiqués dans cette liste des prix, sans devoir en donner le préavis à sa clientèle.
- 21) Nous vous prions d'indiquer le code complet de chaque produit et le prix correspondant dans la commande.
- 22) Les dépliants en circulation sont à caractère purement explicatif; ZILFOR décline toute responsabilité pour les inexactitudes d'impression éventuelles ou pour des indications incorrectes des caractéristiques du produit.
- 23) Toute livraison sur le territoire national relative à des commandes dont le montant net total est inférieur à € 800,00 est effectuée exclusivement en port dû. Pour des montants supérieurs le transport sera déduit à part, indépendamment des modalités de débit. Il est entendu que la marchandise est livrée au niveau de la cour, livraison à l'étage non-compris, sauf accords différents.
- 24) Les prix indiqués ne comprennent pas le montage. Sur demande, on fera toujours une cotation séparée.

**1) Die in dieser Preisliste aufgeführten Artikelpreise verstehen sich als Abgabepreis ohne MWST. Für Rechnungsbeträge unter 150,00 Euro werden die Kosten für die Ausstellung der Bankpapiere in Rechnung gestellt.**

2) Alle Bestellungen verstehen sich als angenommen unter dem Vorbehalt bereits verkaufter Ware und zweckdienlicher Informationen.

3) Die Ware reist auf Risiko und Gefahr des Auftraggebers, auch wenn sie frei Bestimmungsort verkauft wurde.

4) Die Ware versteht sich beim Verlassen unseres Lagers in jeder Hinsicht an den Käufer ausgehändigt und ab diesem Moment tragen wir keinerlei Verantwortung mehr dafür.

5) Wir haften folglich nicht für Verspätungen, Missverständnisse, Verluste und Schäden, die durch das Transportmittel oder dessen Wahl hervorgerufen werden. Beschwerden gegen den Spediteur sind vom Empfänger vorzubringen.

6) ZILFOR behält sich die Möglichkeit vor, die Aufträge auch in mehreren Anläufen abzuwickeln.

7) ZILFOR betrachtet die Auslieferfristen als reine Richtzeit und nicht bindend.

8) Sollten die notwendigen Rohstoffe nicht pünktlich eintreffen, wird dies als höhere Gewalt angesehen. In allen Fällen höherer Gewalt hat ZILFOR das Recht, die Ausführung des Auftrags abzubrechen oder zu verzögern, ohne dass der Kunde infolgedessen irgendeine Entschädigung verlangen kann.

9) Es werden nur die Reklamierungen anerkannt, die per Einschreiben innerhalb von drei Tagen nach Ankunft der Ware geltend gemacht werden. Der Käufer kann die Freigabe der ankommenden Ware nicht verweigern; aus seiner Verweigerung hervorgehende Stillstandszeiten und die damit verbundenen Schäden gehen voll zu seinen Lasten.

10) Die Garantie auf eventuelle Material- und Herstellungsfehler entspricht den gesetzlichen Bestimmungen und hat einen Gültigkeitszeitraum von 24 Monaten ab dem Auslieferdatum (und dem Datum der Transportpapiere).

11) Zurückgehende Ware wird nur dann akzeptiert, wenn die Rückgabe vorher von ZILFOR genehmigt wurde. Die Rückgabe kann nur dann erfolgen, wenn die Ware so verpackt wurde, dass ihr durch den Transport keine weiteren Schäden drohen. Außerdem ist die Ware mit regulären Begleitpapieren zu versehen, d.h. für jeden Artikel müssen Typ, Farbe, Menge, Rechnungsdatum und -Nummer resultieren. Die Gutschrift der zurückgenommenen Ware erfolgt auf Grundlage der Kaufpreise und des Zustands von jedem einzelnen zurückgegebenen Element, der von unserem technischen Büro unanfechtbar beurteilt wird.

12) Auch im Fall von Beschwerden hat ZILFOR das Recht die volle Bezahlung der Lieferung zu verlangen, egal welcher Natur die Beschwerden sind und auch wenn diese auf die verlangte Art und Weise vorgebracht wurden.

13) Für alle Streitigkeiten ist einzig und allein der Gerichtsstand von Treviso zuständig.

14) Bei nicht erfolgter Bezahlung beginnen die kommerziellen Zinssätze zu laufen, all unsere Recht vorbehalten.

15) Die nicht erfolgte Bezahlung bei einer Fälligkeitsfrist oder Veränderungen in der Lage des Käufers geben ZILFOR das Recht, den bestehenden Vertrag ohne weiteres aufzuheben.

16) Die Ware bleibt bis zu ihrer Bezahlung Eigentum von ZILFOR, wobei der Verkäufer das Recht hat diese abzuholen.

17) Elemente, die aufgrund ihrer Größe, ihres Materials und/oder ihrer Farbe außerhalb der Serie sind, müssen vorher von unserem technischen Büro akzeptiert werden, sowohl was die Fertigungszeiten betrifft als auch die Festlegung des Kaufpreises.

18) ZILFOR lehnt jegliche Haftung für Montagefehler ab, sollte die Montage seiner Artikel vor Ort nicht vom eigenen Personal vorgenommen worden sein.

19) Die Übereinstimmung mit dem Muster ist nicht im engeren Sinne zu verstehen, da es Toleranzgrenzen gibt, die in der Regel für die diversen verwendeten Materialien bestehen und anerkannt werden.

20) ZILFOR behält sich das Recht vor, jederzeit jedes Detail der in dieser Preisliste beschriebenen Artikel und Preise zu verändern, ohne die Kunden vorher benachrichtigen zu müssen.

21) Wir bitten darum, in den Bestellungen die komplette Artikelnummer von jedem Produkt und den relativen Preis anzugeben.

22) Die im Umlauf befindlichen Broschüren haben reinen Illustrationscharakter und ZILFOR lehnt jegliche Haftung für eventuelle Druckfehler oder falsche Angaben zu den Produkteigenschaften ab.

23) Auslieferungen im Inland von Bestellungen mit einem Gesamtnettowert von weniger als 800,00 Euro erfolgen ausschließlich per Nachnahme. Bei höheren Beträgen wird der Transport separat behandelt, unabhängig von der Art und Weise der Berechnung. Die Auslieferung der Ware versteht sich im Hof, die Beförderung bis zur Etage ist ausgeschlossen, es sei denn es liegen andere Abmachungen vor.

24) Die aufgeführten Preise beinhalten keine Montage, die – wenn gewünscht – immer separat berechnet wird.





ZIL FOR S.R.L.

Via Fossa, 37 31051 FOLLINA (TV) - Italy

T. 0438/970308

F. 0438/971853

M. [info@zilfor.com](mailto:info@zilfor.com)

[zilfor.com](http://zilfor.com)